

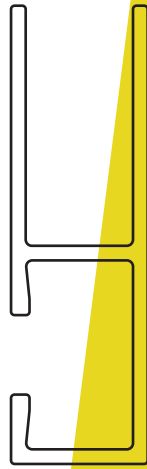

MOVING WALLS



MOVING RAIL

Aufbauanleitung
building instructions

MOVING RAIL

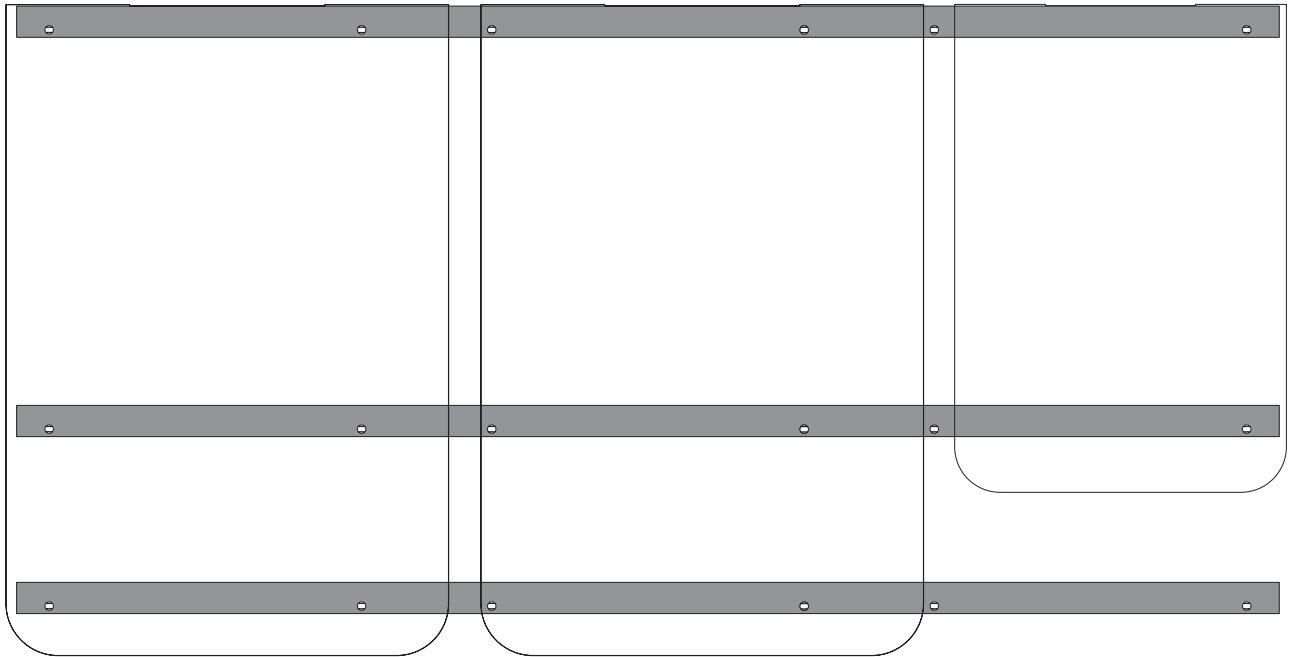

Das Schienensystem Moving Rail dient der Befestigung des mobilen Moving Panel und Moving Acoustic Panel an der Wand und ist aus magnetischen Aluminiumprofilen gefertigt. Die beschreibbaren Präsentationstafeln in beiden Größen sowie das Akustikpanel können mittels des Moving Rail großflächig und temporär an die Wand angebracht und kombiniert werden. Das Moving Rail ist jeweils in drei Längen erhältlich.

The rail system of magnetic aluminium profiles, Moving Rail allows for the attachment of the mobile Moving Panel and Moving Acoustic Panel to the wall. With the help of the Moving Rail, the writeable presentation surfaces in both sizes as well as the acoustic panel can be used and combined on a large-scale and temporarily on the wall. The Moving Rail is available in three sizes respectively.

Übersicht Set Varianten

Overview set variants

Kleine Moving Panel
Small Moving Panel

Große Moving Panel
Large Moving Panel

S1

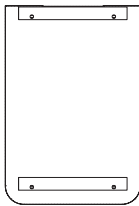

M1

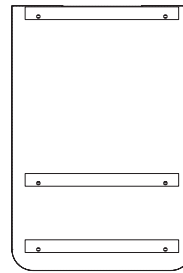

S2

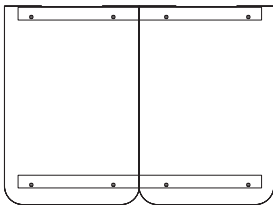

M2

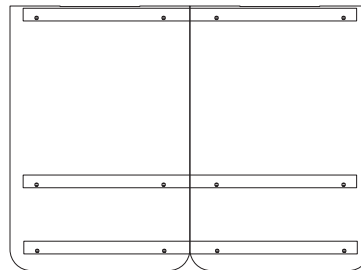



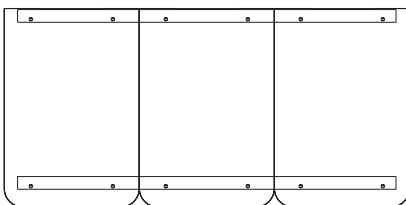



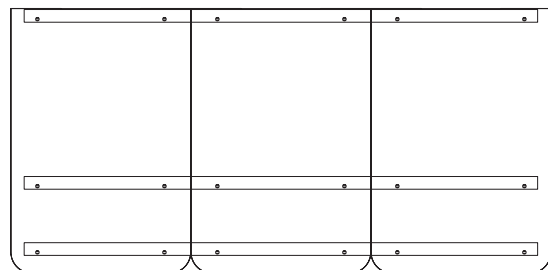



S3



M3









Teileliste Moving Panel Parts list Moving Panel

		S1	S2	S3	M1	M2	M3
Moving Panels S		1	2	3	—	—	—
Moving Panels M		—	—	—	1	2	3
Moving Rail S1		2	—	—	—	—	—
Moving Rail S2		—	2	—	—	—	—
Moving Rail S3		—	—	2	—	—	—
Moving Rail M1		—	—	—	3	—	—
Moving Rail M2		—	—	—	—	3	—
Moving Rail M3		—	—	—	—	—	3
Unterlegscheibe Washer		4	8	12	6	12	18
Pfropfen Plug		2	4	6	2	4	6
Pfropfen, magnetisch Plug, magnetic		2	4	6	4	8	12

Individuelle Sets und Einzelteile auf Anfrage
Individual sets and parts on request

Teileliste Moving Acoustic Panel

Parts list Moving Acoustic Panel

		S2	M3
Moving Acoustic Panel A		1	1
		oder or	
Moving Acoustic Panel B		1	1
Moving Rail S2		3	—
Moving Rail M3		—	3
Unterlegscheibe Washer		12	18
Pfropfen Plug		4	6
Pfropfen, magnetisch Plug, magnetic		8	12

Individuelle Sets und Einzelteile auf Anfrage
Individual sets and parts on request

Maße der Wand-Teile

Dimensions of the wall parts

S1 Moving Rail

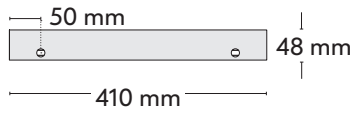

S2 Moving Rail / 1 Moving Acoustic Panel

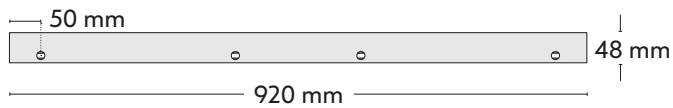

S3 Moving Rail

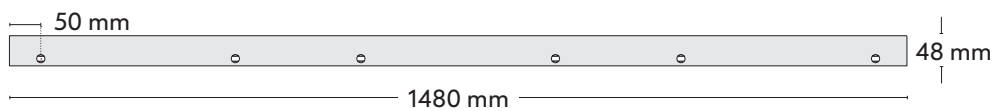

M1 Moving Rail

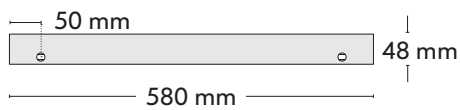

M2 Moving Rail

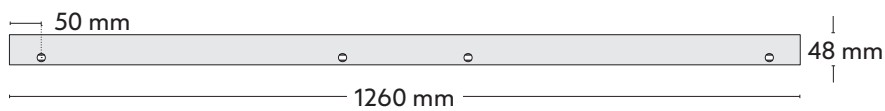

M3 Moving Rail / 2 Moving Acoustic Panel

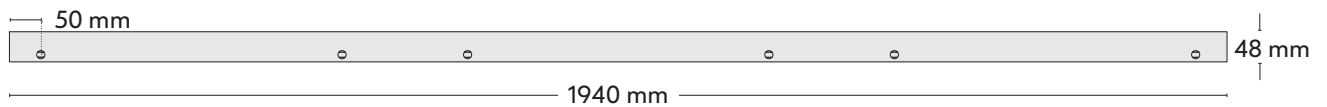

13mm



Unterlegscheibe
Washer

13,5mm



Pfropfen
Plug

13,5mm



Pfropfen, magnetisch
Plug, magnetic

Maße der Panels

Dimensions of panels

Moving Panel M

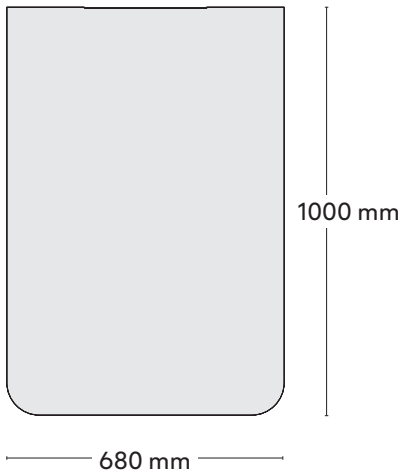

Moving Acoustic Panel A

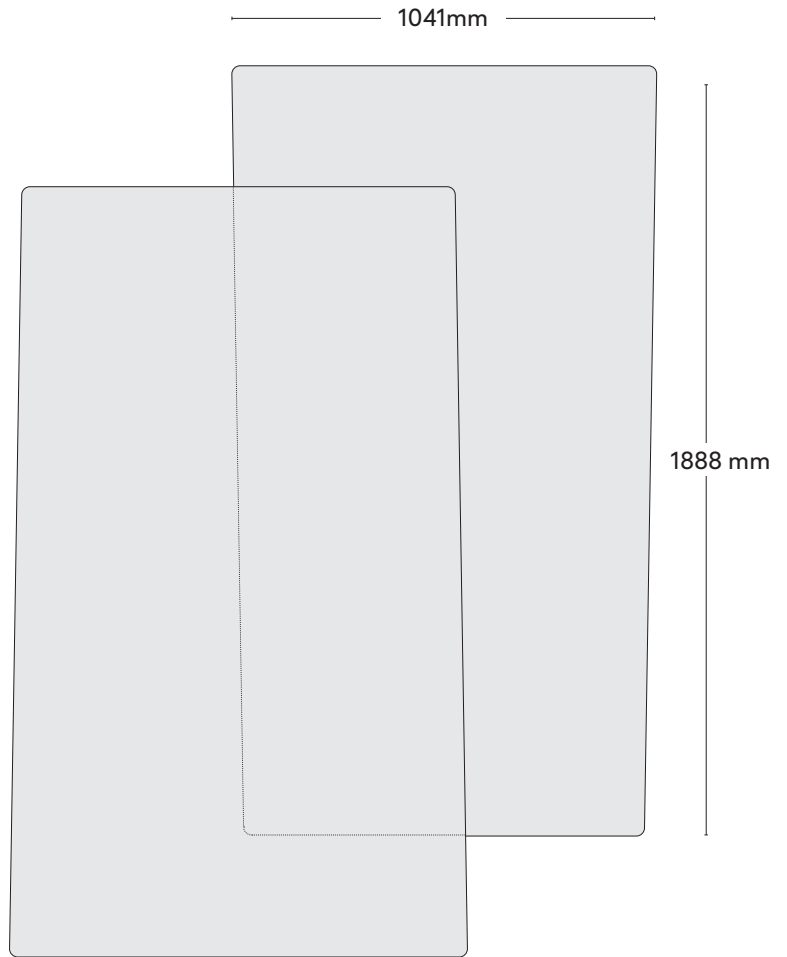

Moving Panel S

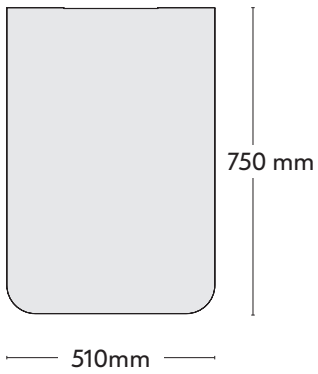

Moving Acoustic Panel B

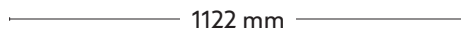

Moving Table

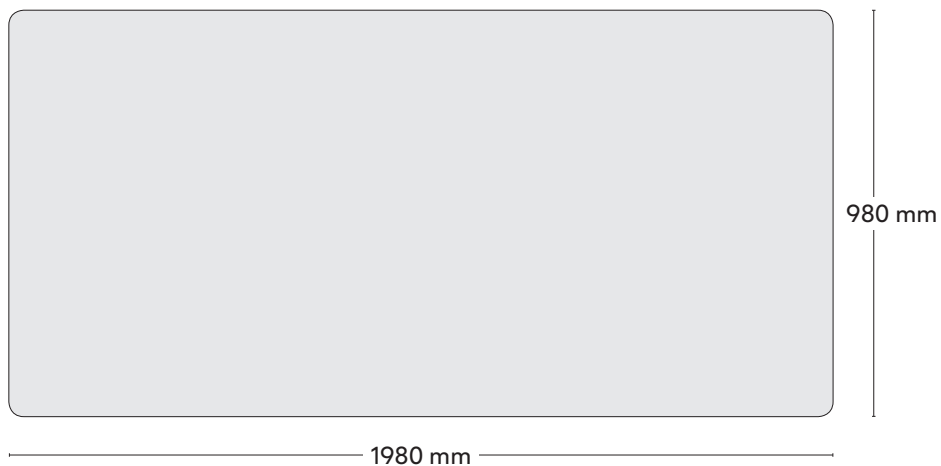

Benötigtes Werkzeuge und Material

Required tools and material



Schrauben (4x40mm)
Screw 4x40mm



Passender Dübel
Dowel

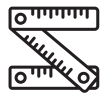

Zollstock
Ruler



Wasserwaage
Spirit level



Akkuschrauber mit Bit
Cordless screwdriver with bit



Schlagbohrmaschine mit Bohrer
Impact drilling machine with drill



Stift zum Anzeichnen
Pen for marking

Montage der Moving Rails für Moving Panels und Moving Table

Assembly of the Moving Rails for Moving Panels and Moving Table

1

Erste Löcher links oder rechts vermessen & anzeichnen.
Measure left or right first holes & mark.

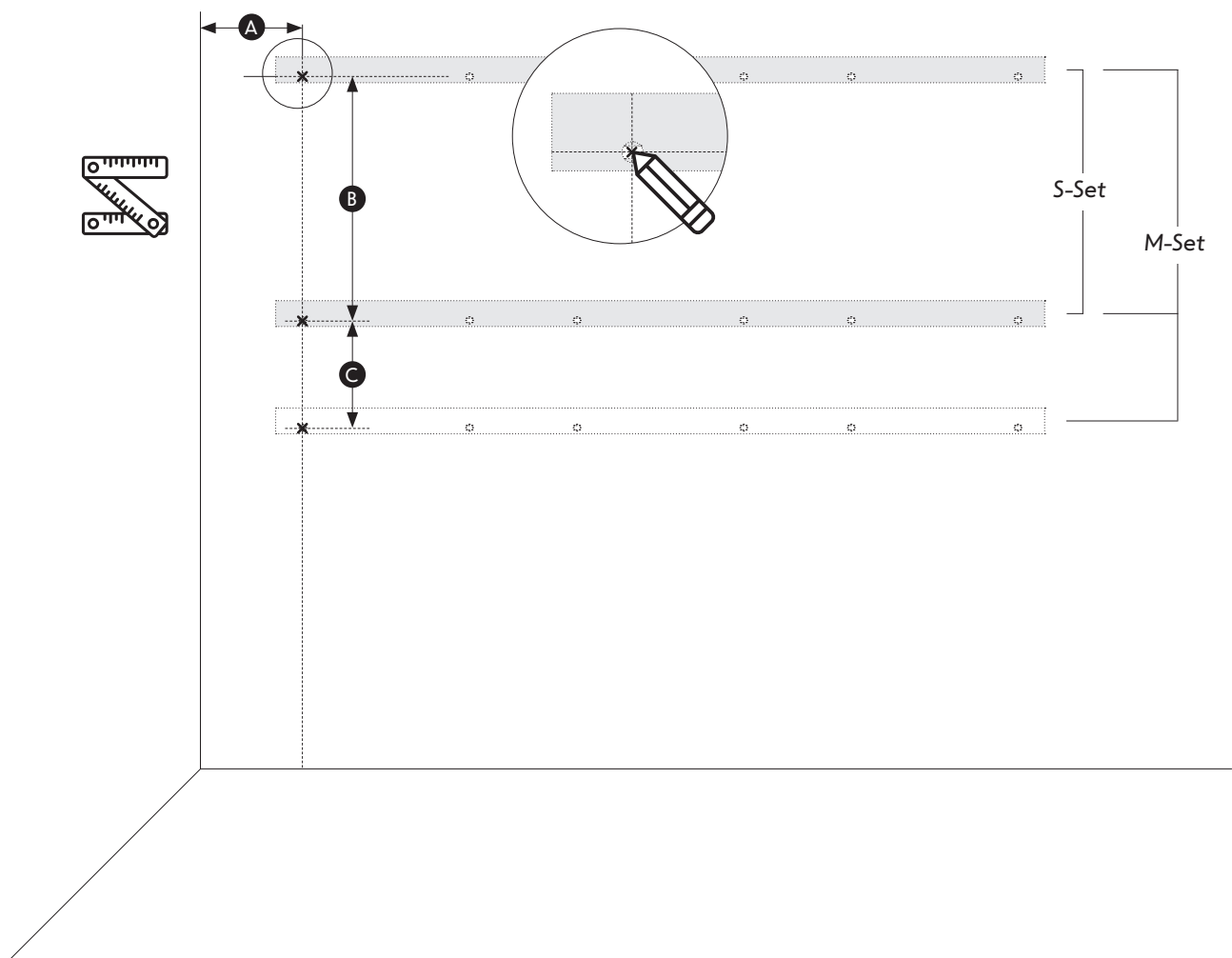

- Ⓐ 100 mm Mindestabstand zur Wand, Min. distance to the wall.
- Ⓑ 550 mm Markierung zweite Leiste, Mark second bar. (S- & M-Set)
- Ⓒ 250 mm Markierung dritte Leiste, Mark third bar. (nur/only M-Set)

Montage der Moving Rails für Moving Acoustic Panels

Assembly of the Moving Rails for Moving Acoustic Panels

1

Erste Löcher links oder rechts vermessen & anzeichnen.
Measure left or right first holes & mark.

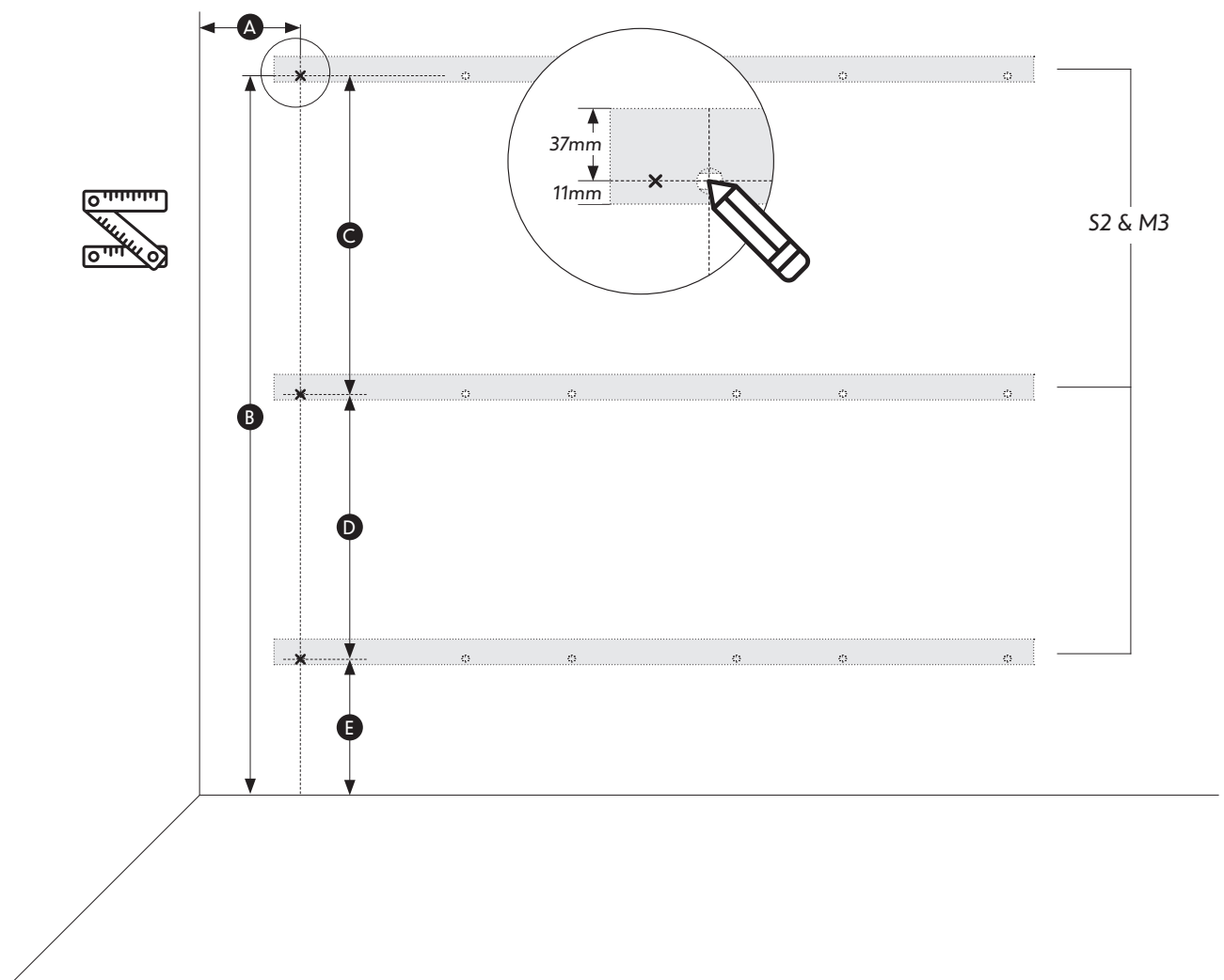

- Ⓐ 152 mm Mindestabstand zur Wand, Min. distance to the wall.
- Ⓑ 1970 mm Mindestabstand zum Boden, Min. distance to the ground.
- Ⓒ 710 mm Markierung zweite Leiste, Mark second bar.
- Ⓓ 710 mm Markierung dritte Leiste, Mark third bar.
- Ⓔ 542 mm Abstand zum Boden der dritten Leiste, distance to the ground from third bar.

Montage der Moving Rails

Assembly of the Moving Rails

2

1x je Rail bohren, Dübel setzen.
Drill once per rail, place dowel.

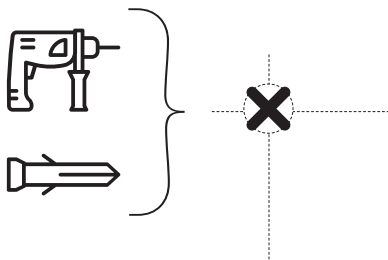

3

Locker mit Unterlegscheibe anschrauben.
Loosely screw on with a washer.

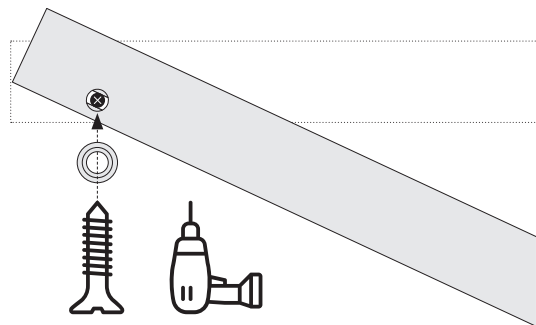

4

Jeweils mit Wasserwaage ausrichten,
restliche Löcher anzeichnen.
Align each with spirit level, mark remaining holes.

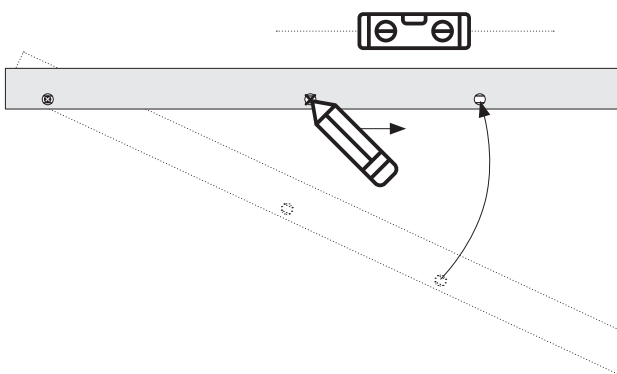

5

Angezeichnete Löcher bohren,
restliche Schrauben anschrauben.
Drilling marked holes, screw on remaining screws.

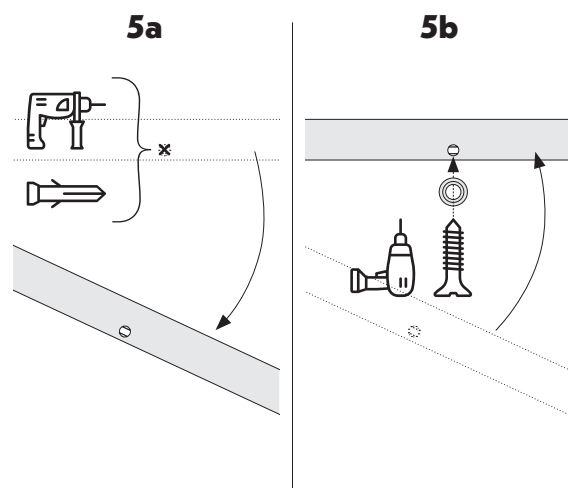

Alle Schrauben anziehen. Je Rail Schritte 3 bis 5 wiederholen.
Tighten all screws. Repeat steps 3 to 5 for each rail.

6

Pfropfen anbringen und Panel einhängen
Attach plugs and hang in the panel

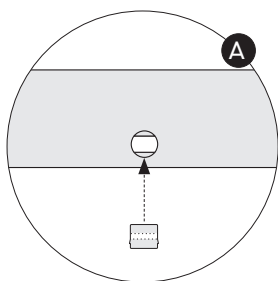
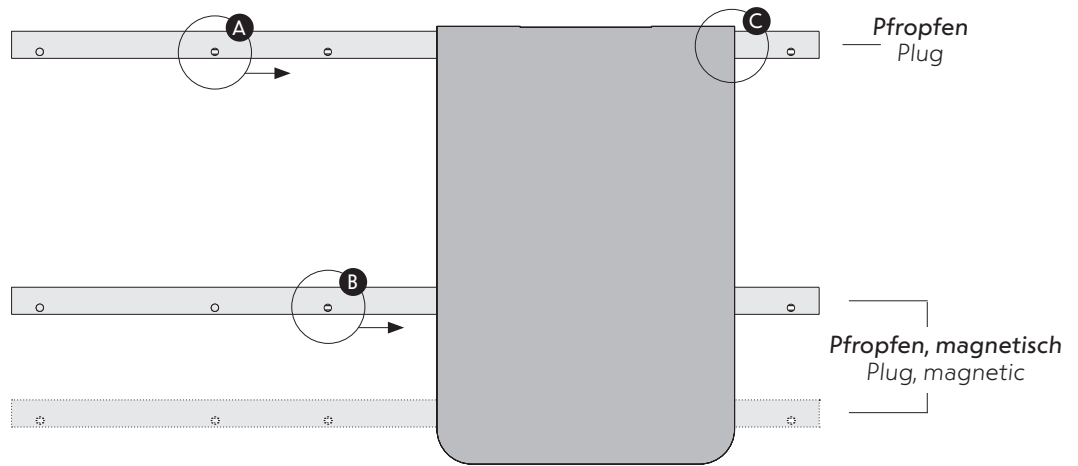

Pfropfen
Plug

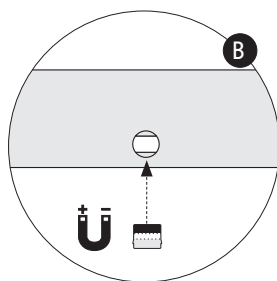

Pfropfen, magnetisch
Plug, magnetic

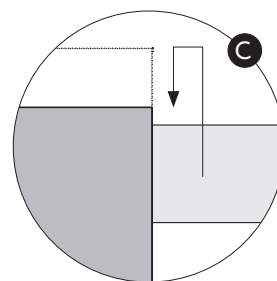

Panel einhängen
Hang in the panel

HILFE BENÖTIGT?
NEED HELP?



MOVING WALLS

Moving Walls Ltd.
Bruchmattstrasse 7
6003 Luzern
Switzerland

info@moving-walls.com

+41 41 241 06 44

GIVE IDEAS LIFE
www.moving-walls.com